

2CBR 410 26 ST

Código: 009.410

**COMPRESSOR RADIAL
SIMPLES ESTÁGIO
MOTOR TRIFÁSICO**

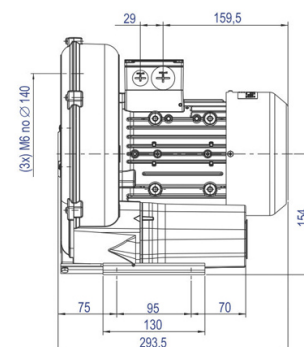
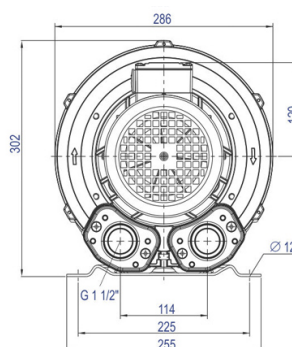
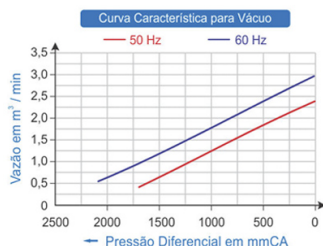
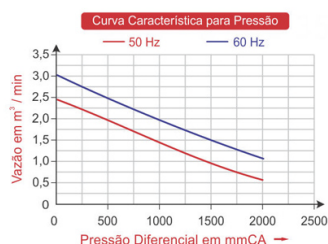

TIPO	Mono Estágio
MOTOR ELÉTRICO	1,3kW, 1,74 cv, Trifásico , 220-290D/380-500Y Volts, 4,5/2,6 Ampéres, 50 / 60 Hz
VÁCUO MÁX.	2.100 mmCA
PRESSÃO MÁX.	2.000 mmCA
VAZÃO MÁX.	3,16 m ³ /min
PRESSÃO SONORA	64 dB(a)
PESO LÍQUIDO	18,0 kg