

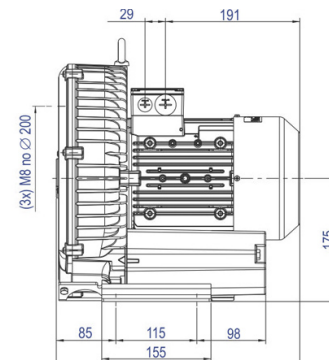

2CBR 510 36 ST

Código: 011.510

COMPRESSOR RADIAL
SIMPLES ESTÁGIO
MOTOR TRIFÁSICO

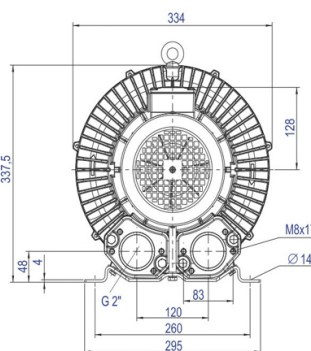
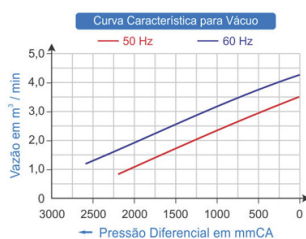
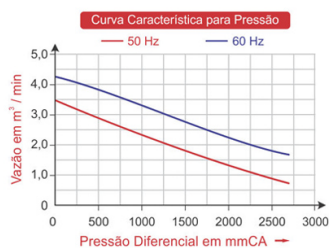
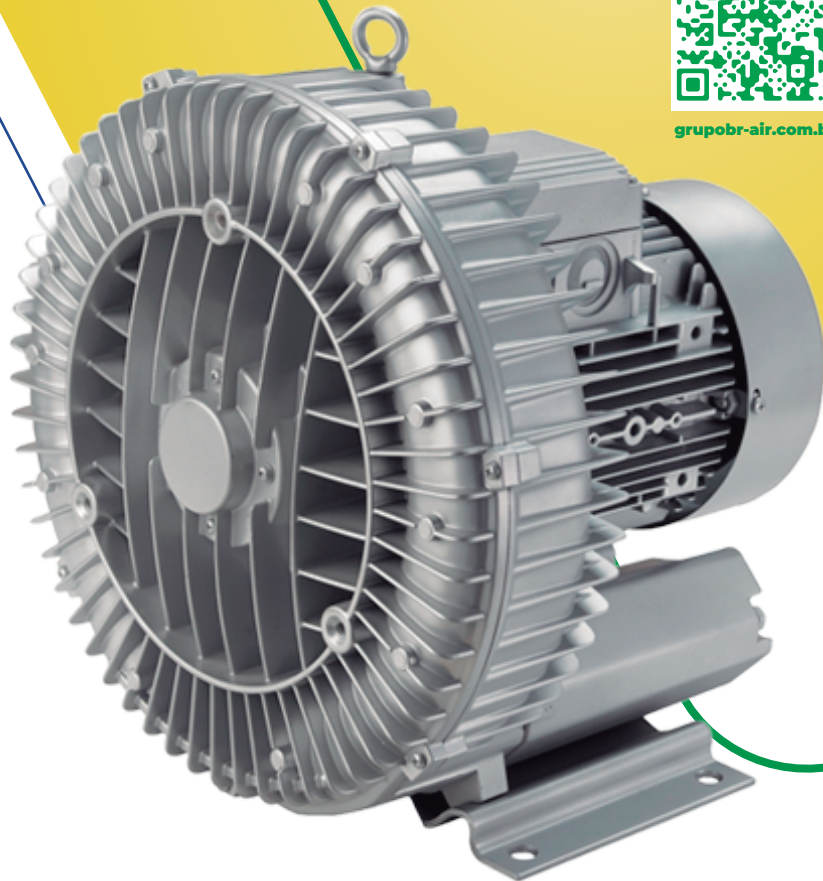

TIPO	Mono Estágio
MOTOR ELÉTRICO	2,55kW, 3,42 cv, Trifásico, 220-290D/380-500Y Volts, 8,1/4,6 Ampéres, 50 / 60 Hz
VÁCUO MÁX.	2.600mmCA
PRESSÃO MÁX.	2.700 mmCA
VAZÃO MÁX.	4,25 m ³ /min
PRESSÃO SONORA	70 dB(a)
PESO LÍQUIDO	29,0 kg