

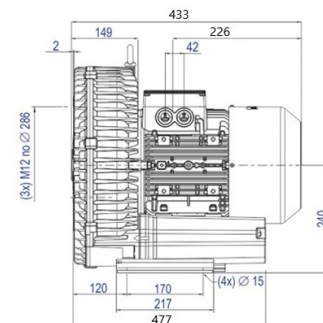

2CBR 810 16 ST

Código: 015.810

COMPRESSOR RADIAL
SIMPLES ESTÁGIO
MOTOR TRIFÁSICO

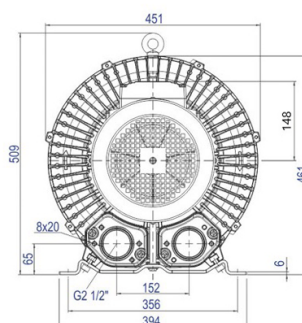
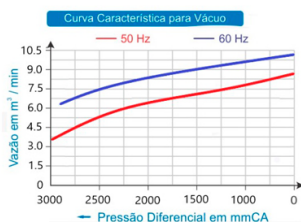
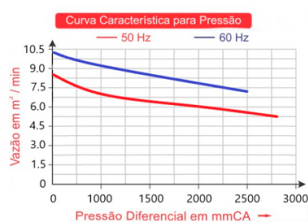

TIPO	Mono Estágio
MOTOR ELÉTRICO	6,3kW, 8,45 cv, Trifásico, 220-290D/380-500Y Volts, 19,0/11,0 Ampéres, 50 / 60 Hz
VÁCUO MÁX.	3.000mmCA
PRESSÃO MÁX.	2.800 mmCA
VAZÃO MÁX.	10,3m³/min
PRESSÃO SONORA	74 dB(a)
PESO LÍQUIDO	63,0 kg