

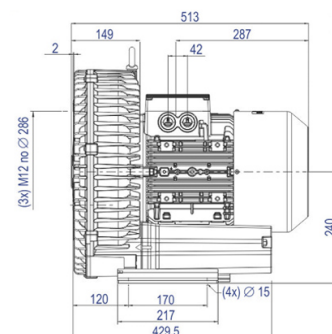

2CBR 810 26 ST

Código: 016.810

COMPRESSOR RADIAL
SIMPLES ESTÁGIO
MOTOR TRIFÁSICO

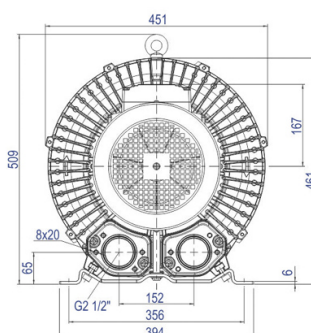
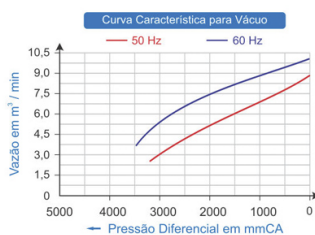
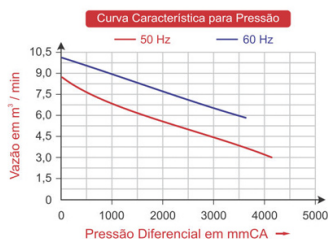

TIPO	Mono Estágio
MOTOR ELÉTRICO	8,60kW, 11,53 cv, Trifásico, 220-290D/380-500Y Volts, 26,2/15,1 Ampéres, 50 / 60 Hz
VÁCUO MÁX.	3.500 mmCA
PRESSÃO MÁX.	3.600 mmCA
VAZÃO MÁX.	10,33m ³ /min
PRESSÃO SONORA	74 dB(a)
PESO LÍQUIDO	78,0 kg